

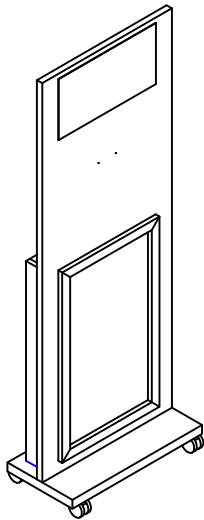







Scan QR code to visit product page

Hand Sanitizer Unit with Chalkboard Chalkboard Assembly Instructions

SKU: FGAHSCBDK, FGAHSCBLT



Pictured: Front of unit

Contents					
Ref.	Qty.	Description	Ref.	Qty.	Description
A	1	Billboard Panel	H1	30	Cam Lock 
B1	1	Left Side Panel	H2	30	Cam Post 
B2	1	Right Side Panel	H3	2	Caster with Brake 
C	2	Horizontal Shelf Panel	H4	2	Caster without Brake 
D	2	Bottom Shelf Panel	H5	16	Caster Screw 
E	1	Bottom Panel	H6	4	Bolt 
F	1	Base			

NOTE: Phillips Head screwdriver required for assembly.

CAM LOCKING DETAIL & SEQUENCE

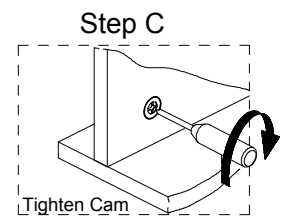
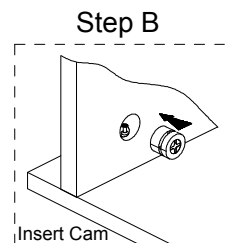
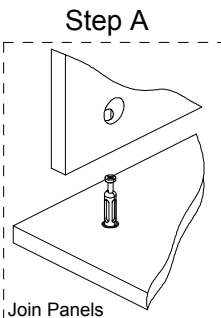
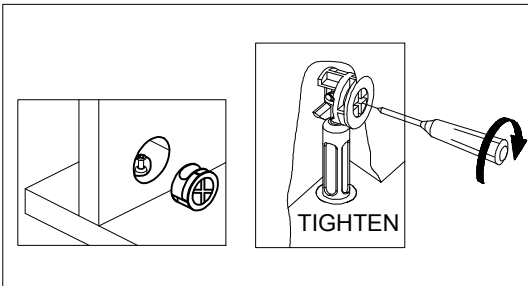

NOTE: Cams will be used to assemble components in steps 1-3.

TWO ADULTS REQUIRED FOR ASSEMBLY

1

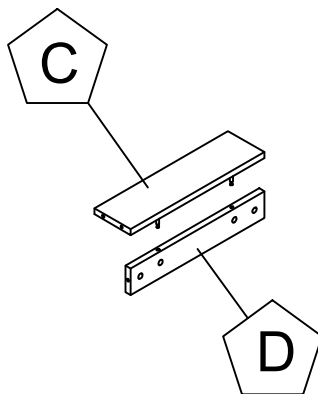

x2
This step creates two compartments for back of unit.

2

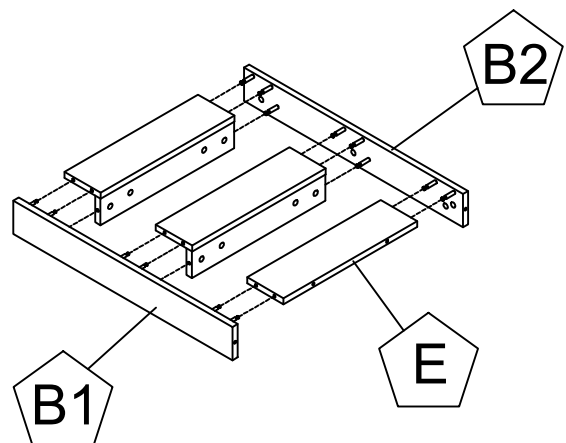

3

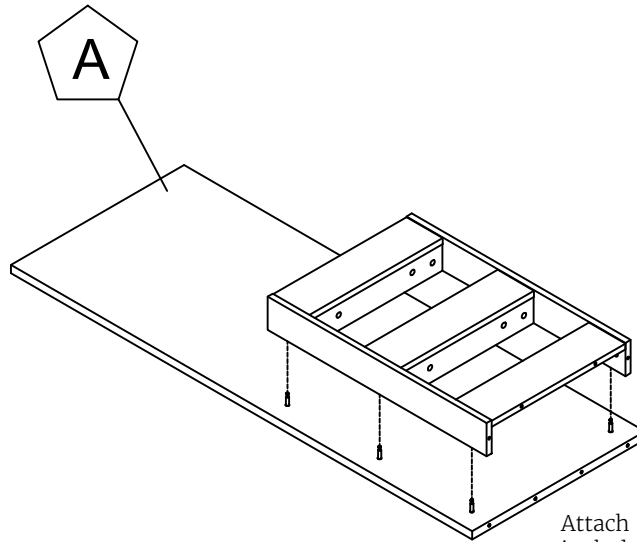

Attach compartments on back side. Front includes pre-drilled holes for sanitizer unit, located under magnetic panel.

4

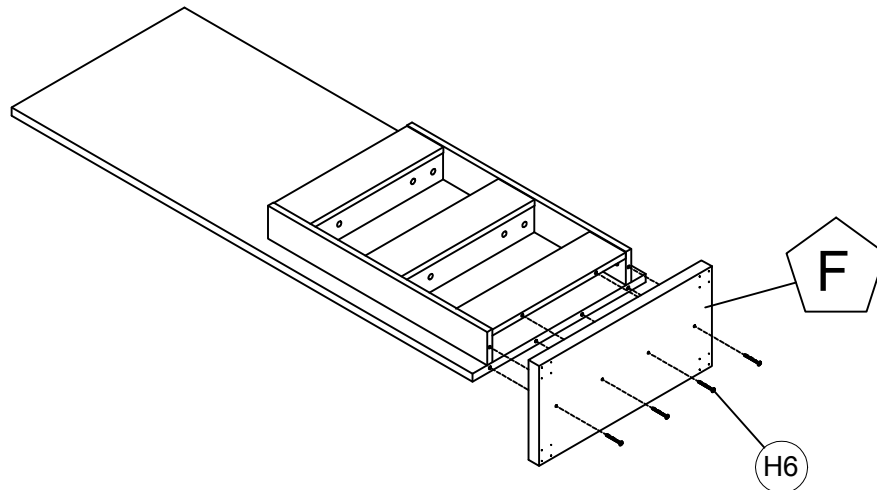

5

